

APPROVAL SHEET

MODEL NO.: _____

CUSTOMER:

CUSTOMER'S APPROVAL:

AUTHORIZED SIGNATURE/STAMP

DATE

MANUFACTURER:

The Fourth Industrial Zone, Luokeng Village, Xiaotie District, Xiaojinkou Town, Huizhou City, Guangdong Province, China

Tel: 0752-7213069/7213070

Fax: 0752-7213065

Submitted by:

Approved by:

Date:

Performance Specification

Model	Marketing	V _{max} (V dc)	I _{max} (A)	I _{hold} @25°C (A)	I _{trip} @25°C (A)	P _d Typ. (W)	Maximum Time To Trip		Resistance		认证
							Current (A)	Time (Sec)	R _{i min} (Ω)	R _{1max} (Ω)	UL
SMD1206R005SF	RA	60.0	10	0.05	0.15	0.4	0.25	1.50	3.600	50.000	
SMD1206R005SF24v	RA	24.0	10	0.05	0.15	0.4	0.25	1.50	3.600	50.000	√
SMD1206R010SF	R1	60.0	10	0.10	0.25	0.4	0.50	1.00	1.600	15.000	
SMD1206R010SF24v	R1	24.0	10	0.10	0.25	0.4	0.50	1.00	1.600	15.000	√
SMD1206R012SF	R1	60.0	10	0.12	0.29	0.4	0.50	1.00	1.600	15.000	
SMD1206R012SF24v	R1	24.0	10	0.12	0.29	0.4	0.50	1.00	1.600	13.000	√
SMD1206R016SF33v	R2	33.0	10	0.16	0.37	0.4	1.00	0.30	1.000	6.000	
SMD1206R016SF24v	R2	24.0	10	0.16	0.37	0.4	1.00	0.30	1.000	6.000	√
SMD1206R016SF	R2	16.0	10	0.16	0.37	0.4	1.00	0.30	1.000	6.000	√
SMD1206R020SF	R2	24.0	10	0.20	0.46	0.6	8.00	0.08	0.350	2.700	√
SMD1206R020SF30V	R2	30.0	10	0.20	0.46	0.6	8.00	0.08	0.350	2.700	
SMD1206R020SF48V	R2	48.0	10	0.20	0.46	0.6	8.00	0.08	0.350	2.700	
SMD1206R025SF	R2	16.0	10	0.25	0.50	0.6	8.00	0.08	0.350	2.500	√
SMD1206R025SF24V	R2	24.0	10	0.25	0.50	0.6	8.00	0.08	0.350	2.500	√
SMD1206R025SF30V	R2	30.0	10	0.25	0.50	0.6	8.00	0.08	0.350	2.500	
SMD1206R025SF48V	R2	48.0	10	0.25	0.50	0.6	8.00	0.08	0.350	2.500	
SMD1206R035SF	R3	6.0	35	0.35	0.75	0.6	8.00	0.10	0.250	1.300	√
SMD1206R035SF16V	R3	16	35	0.35	0.75	0.6	8.00	0.10	0.250	1.300	
SMD1206R035SF30V	R3	30.0	35	0.35	0.75	0.6	8.00	0.10	0.250	1.300	
SMD1206R050SF	R5	6.0	35	0.50	1.00	0.6	8.00	0.10	0.150	0.700	√
SMD1206R050SF13.2V	R5	13.2	35	0.50	1.00	0.6	8.00	0.10	0.150	0.700	
SMD1206R050SF16V	R5	16.0	35	0.50	1.00	0.6	8.00	0.10	0.150	0.700	
SMD1206R050SF30V	R5	30.0	35	0.50	1.00	0.6	8.00	0.10	0.150	0.700	
SMD1206R050SF33V	R5	33.0	35	0.50	1.00	0.6	8.00	0.10	0.150	0.700	
SMD1206R075SF	R7	6.0	35	0.75	1.50	0.6	8.00	0.20	0.090	0.500	√
SMD1206R075SF16V	R7	16.0	35	0.75	1.50	0.6	8.00	0.20	0.090	0.500	
SMD1206R075SF30V	R7	30.0	35	0.75	1.50	0.6	8.00	0.20	0.090	0.500	
SMD1206R100SF	R0	6.0	35	1.00	1.80	0.6	8.00	0.30	0.050	0.270	√
SMD1206R100SF16V	R0	16.0	35	1.00	1.80	0.6	8.00	0.30	0.050	0.270	
SMD1206R100SF24V	R0	24.0	35	1.00	1.80	0.6	8.00	0.30	0.050	0.270	
SMD1206R100SF30V	R0	30.0	35	1.00	1.80	0.6	8.00	0.30	0.050	0.270	
SMD1206R110SF	R0	6.0	35	1.10	2.20	0.6	8.00	0.30	0.040	0.250	√
SMD1206R110SF16V	R0	16.0	35	1.10	2.20	0.6	8.00	0.30	0.040	0.250	
SMD1206R110SF24V	R0	24.0	35	1.10	2.20	0.6	8.00	0.30	0.040	0.250	
SMD1206R110SF30V	R0	30.0	35	1.10	2.20	0.6	8.00	0.30	0.040	0.250	
SMD1206R150SF	RX	6.0	35	1.50	3.00	0.8	8.00	0.30	0.025	0.130	√
SMD1206R150SF13.2V	RX	13.2	35	1.50	3.00	0.8	8.00	0.30	0.025	0.130	
SMD1206R150SF16V	RX	16	35	1.50	3.00	0.8	8.00	0.30	0.025	0.130	
SMD1206R200SF	RY	6.0	35	2.00	3.50	0.8	8.00	1.50	0.015	0.080	√

R HuiZhou DaRong Electronic Technology CO.,LTD

SMD1206 HF Series Surface Mount PTC Devices

SMD1206R200SF12V	RY	12.0	35	2.00	3.50	0.8	8.00	1.50	0.015	0.080	
SMD1206R250SF	RZ	6.0	35	2.50	5.00	0.8	8.00	2.00	0.010	0.060	
SMD1206R260SF	RZ	6.0	35	2.60	5.20	0.8	8.00	2.00	0.010	0.060	
SMD1206R300SF	RU	6.0	35	3.00	6.00	1.0	8.00	4.00	0.010	0.050	
SMD1206R350SF	R-	6.0	35	3.50	7.00	1.2	10.0	5.00	0.005	0.040	

V max = Maximum operating voltage device can withstand without damage at rated current (I max).

I max = Maximum fault current device can withstand without damage at rated voltage (V max).

I hold = Hold Current. Maximum current device will not trip in 25°C still air.

I trip = Trip Current. Minimum current at which the device will always trip in 25°C still air.

Pd = Power dissipation when device is in the tripped state in 25°C still air environment at rated voltage.

Ri min/max = Minimum/Maximum device resistance prior to tripping at 25°C.



R1max = Maximum device resistance is measured one hour post reflow.

CAUTION : Operation beyond the specified ratings may result in damage and possible arcing and flame.

Environmental Specifications

Test	Conditions	Resistance change
Passive aging	+85°C, 1000 hrs.	±5% typical
Humidity aging	+85°C, 85% R.H. , 168 hours	±5% typical
Thermal shock	+85°C to -40°C, 20 times	±33% typical
Resistance to solvent	MIL-STD-202,Method 215	No change
Vibration	MIL-STD-202,Method 201	No change
Ambient operating conditions : - 40 °C to +85 °C		
Maximum surface temperature of the device in the tripped state is 125 °C		

Agency Approval and Environmental Compliance

Agency	File Number	Regulation	Standard
UL	E486890		2002/95/EC
TUV	pending		EN14582

Thermal Derating Chart

Recommended Hold Current(A) at Ambient Temperature(°C)

Model	Ambient Operation Temperature								
	-40°C	-20°C	0°C	25°C	40°C	50°C	60°C	70°C	85°C
SMD1206R005SF	0.074	0.066	0.058	0.05	0.0425	0.0375	0.035	0.03	0.0275
SMD1206R010SF	0.148	0.132	0.116	0.10	0.085	0.075	0.07	0.06	0.055
SMD1206R012SF	0.18	0.16	0.14	0.12	0.10	0.09	0.08	0.07	0.07
SMD1206R016SF	0.24	0.21	0.18	0.16	0.14	0.13	0.12	0.11	0.10
SMD1206R020SF	0.30	0.26	0.23	0.20	0.17	0.15	0.14	0.12	0.11
SMD1206R025SF	0.37	0.33	0.29	0.25	0.22	0.20	0.17	0.15	0.12
SMD1206R035SF	0.50	0.45	0.40	0.35	0.30	0.27	0.24	0.21	0.15
SMD1206R050SF	0.71	0.64	0.57	0.50	0.42	0.39	0.35	0.31	0.25
SMD1206R075SF	1.14	1.01	0.88	0.75	0.65	0.59	0.54	0.49	0.41
SMD1206R100SF	1.45	1.31	1.15	1.00	0.84	0.77	0.69	0.61	0.48

HuiZhou DaRong Electronic Technology CO.,LTD

SMD1206 HF Series Surface Mount PTC Devices

SMD1206R110SF	1.60	1.45	1.30	1.10	0.95	0.80	0.72	0.66	0.55
SMD1206R150SF	2.18	1.94	1.72	1.50	1.28	1.17	1.06	0.96	0.77
SMD1206R200SF	2.88	2.63	2.34	2.00	1.74	1.58	1.42	1.17	0.93
SMD1206R250SF	3.30	3.10	2.82	2.50	2.16	1.98	1.83	1.54	1.33
SMD1206R260SF	3.43	3.22	2.93	2.60	2.23	2.03	1.87	1.57	1.35
SMD1206R300SF	4.05	3.66	3.36	3.00	2.50	2.28	2.00	1.62	1.35
SMD1206R350SF	4.65	4.23	3.92	3.50	2.92	2.68	2.35	1.91	1.42

Thermal Derating Curve

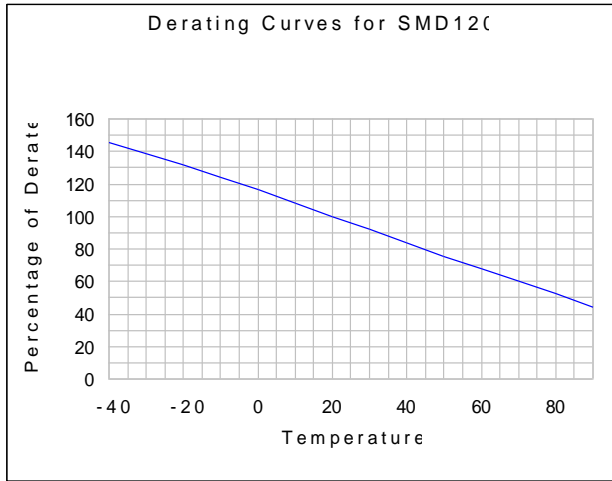

Average Time-Current Curve

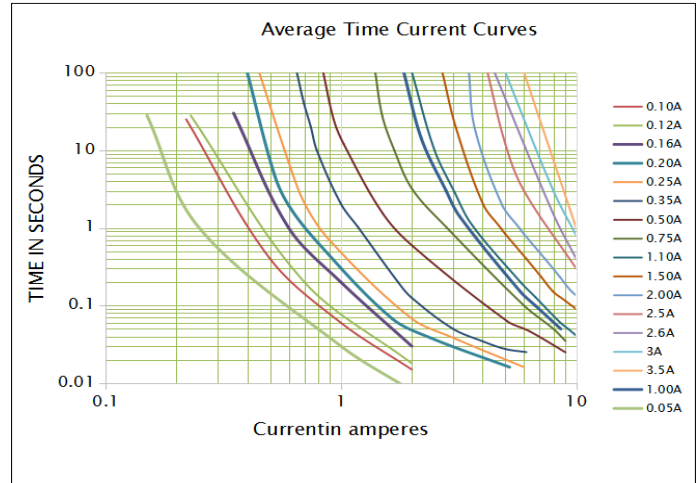

Soldering Parameters

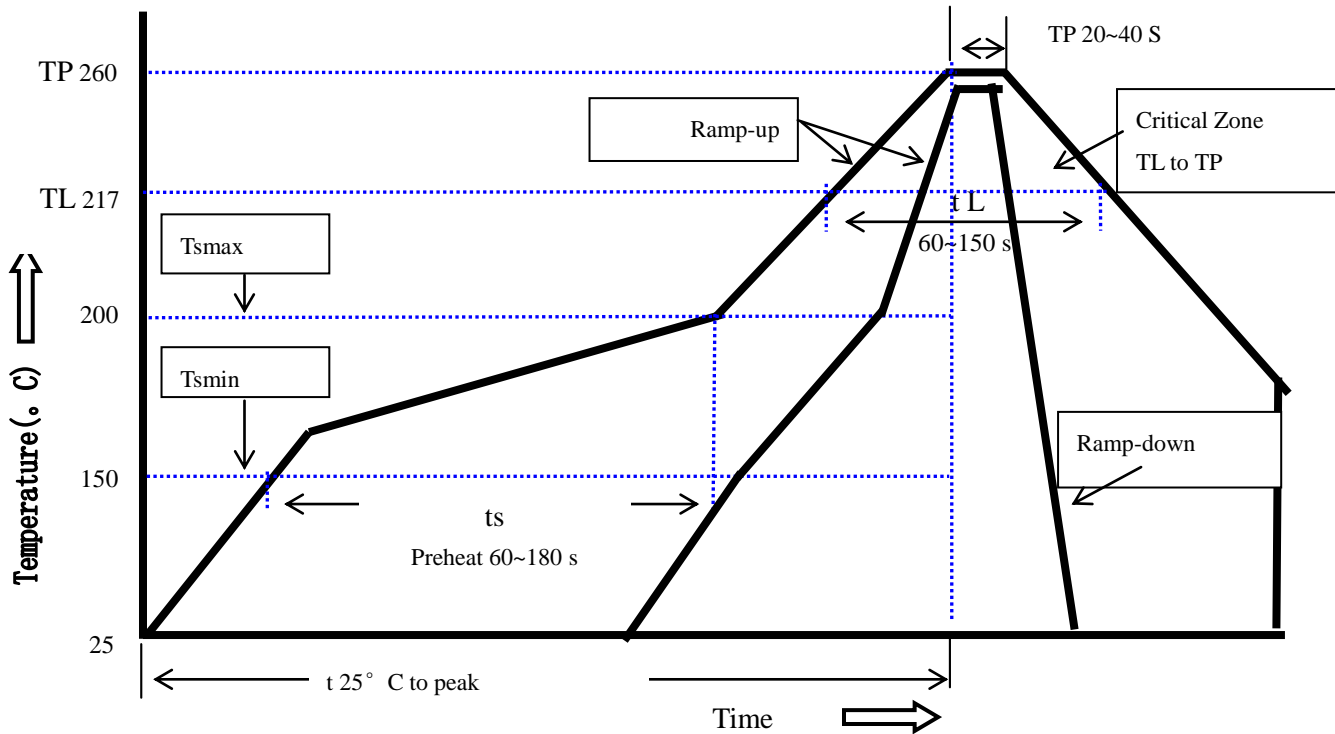

Profile Feature	Pb-Free Assembly
Average Ramp-Up Rate(Ts max to T p)	3°C/second max.
Preheat	
-Temperature Min(Ts min)	150°C
-Temperature Max(Ts max)	200°C

R HuiZhou DaRong Electronic Technology CO.,LTD

SMD1206 HF Series Surface Mount PTC Devices

-Time(Ts min to Ts max)	60~180 seconds
Time maintained above:	
-Temperature(TL)	217°C
-Time(tL)	60~150 seconds
Peak Temperature(Tp)	260°C
Ramp-Down Rate	6°C/second max.
Time 25°C to Peak Temperature	8 minutes max
Storage Condition	0°C~30°C,30%~60%RH

Recommended reflow methods: IR, vapor phase oven, hot air oven, N2 environment for lead-free

Recommended maximum paste thickness is 0.25mm

Devices can be cleaned using standard industry methods and solvents.

Note 1: All temperature refer to topside of the package, measured on the package body surface.

Note 2: If reflow temperatures exceed the recommended profile, devices may not meet the performance requirements.

Physical Dimensions(mm.)

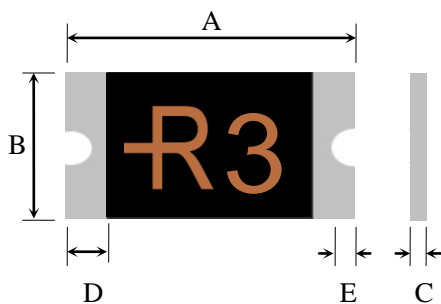

Model	A		B		C		D	E
	Min.	Max.	Min.	Max.	Min.	Max.	Min.	Min.
SMD1206R005SF24v	3.00	3.60	1.50	1.90	0.60	1.20	0.15	0.10
SMD1206R005SF	3.00	3.60	1.50	1.90	0.60	1.20	0.15	0.10
SMD1206R010SF24v	3.00	3.60	1.50	1.90	0.60	1.20	0.15	0.10
SMD1206R010SF	3.00	3.60	1.50	1.90	0.60	1.20	0.15	0.10
SMD1206R012SF24v	3.00	3.60	1.50	1.90	0.60	1.20	0.15	0.10
SMD1206R012SF	3.00	3.60	1.50	1.90	0.60	1.20	0.15	0.10
SMD1206R016SF	3.00	3.60	1.50	1.90	0.40	1.00	0.15	0.10
SMD1206R016SF24v	3.00	3.60	1.50	1.90	0.40	1.00	0.15	0.10
SMD1206R016SF33v	3.00	3.60	1.50	1.90	0.40	1.00	0.15	0.10
SMD1206R020SF	3.00	3.60	1.50	1.90	0.40	1.00	0.15	0.10
SMD1206R020SF30V	3.00	3.60	1.50	1.90	0.40	1.00	0.15	0.10
SMD1206R020SF48V	3.00	3.60	1.50	1.90	0.40	1.00	0.15	0.10
SMD1206R025SF	3.00	3.60	1.50	1.90	0.40	1.00	0.15	0.10
SMD1206R025SF24V	3.00	3.60	1.50	1.90	0.40	1.00	0.15	0.10
SMD1206R025SF30V	3.00	3.60	1.50	1.90	0.40	1.00	0.15	0.10
SMD1206R025SF48V	3.00	3.60	1.50	1.90	0.40	1.00	0.15	0.10

R HuiZhou DaRong Electronic Technology CO.,LTD

SMD1206 HF Series Surface Mount PTC Devices

SMD1206R035SF	3.00	3.60	1.50	1.90	0.35	0.8	0.15	0.10
SMD1206R035SF16V	3.00	3.60	1.50	1.90	0.35	0.8	0.15	0.10
SMD1206R035SF30V	3.00	3.60	1.50	1.90	0.40	0.9	0.15	0.10
SMD1206R050SF	3.00	3.60	1.50	1.90	0.35	0.8	0.15	0.10
SMD1206R050SF13.2V	3.00	3.60	1.50	1.90	0.35	0.80	0.15	0.10
SMD1206R050SF16V	3.00	3.60	1.50	1.90	0.35	0.8	0.15	0.10
SMD1206R050SF30V	3.00	3.60	1.50	1.90	0.50	1.00	0.15	0.10
SMD1206R050SF33V	3.00	3.60	1.50	1.90	0.60	1.50	0.15	0.10
SMD1206R075SF	3.00	3.60	1.50	1.90	0.35	0.80	0.15	0.10
SMD1206R075SF16V	3.00	3.60	1.50	1.90	0.50	1.00	0.15	0.10
SMD1206R075SF30V	3.00	3.60	1.50	1.90	0.5	1.00	0.15	0.10
SMD1206R100SF	3.00	3.60	1.50	1.90	0.35	0.80	0.15	0.10
SMD1206R100SF16V	3.00	3.60	1.50	1.90	0.50	1.00	0.15	0.10
SMD1206R100SF24V	3.00	3.60	1.50	1.90	0.50	1.00	0.15	0.10
SMD1206R100SF30V	3.00	3.60	1.50	1.90	0.70	1.30	0.15	0.10
SMD1206R110SF	3.00	3.60	1.50	1.90	0.35	0.80	0.15	0.10
SMD1206R110SF16v	3.00	3.60	1.50	1.90	0.50	1.00	0.15	0.10
SMD1206R110SF24v	3.00	3.60	1.50	1.90	0.50	1.00	0.15	0.10
SMD1206R110SF30V	3.00	3.60	1.50	1.90	0.70	1.30	0.15	0.10
SMD1206R150SF	3.00	3.60	1.50	1.90	0.50	1.00	0.15	0.10
SMD1206R150SF13.2V	3.00	3.60	1.50	1.90	1.00	1.60	0.15	0.10
SMD1206R150SF16V	3.00	3.60	1.50	1.90	1.00	1.60	0.15	0.10
SMD1206R200SF	3.00	3.60	1.50	1.90	0.7	1.30	0.15	0.10
SMD1206R200SF12V	3.00	3.60	1.50	1.90	1.00	1.60	0.15	0.10
SMD1206R250SF	3.00	3.60	1.50	1.90	1.00	1.60	0.15	0.10
SMD1206R260SF	3.00	3.60	1.50	1.90	1.00	1.60	0.15	0.10
SMD1206R300SF	3.00	3.60	1.50	1.90	1.00	1.60	0.15	0.10
SMD1206R350SF	3.00	3.60	1.50	1.90	1.00	1.60	0.15	0.10

Termination Pad Characteristics

Terminal pad materials: Tin-plated Nickel-Copper

Terminal pad solder ability: Meets EIA specification RS186-9E and ANSI/J-STD-002 Category 3.

Recommended Pad Layout (mm.)

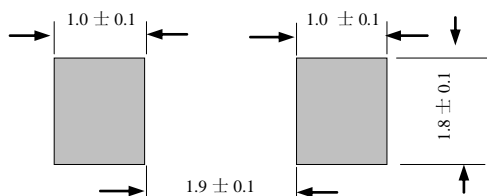

Packaging Quantity

Part Number	Quantity
SMD1206R005.010.012.150.200.260.300SF	3500 pcs/reel
SMD1206R020.025.035.050.075.100.110SF	4500 pcs/reel

Tape & reel packaging per EIA481-1

Tape And Reel Specifications (mm)

Governing Specifications		EIA 481-1
W		8.15 ± 0.3
P0		4.0 ± 0.10
P1		4.0 ± 0.10
P2		2.0 ± 0.05
A0		1.95 ± 0.10
B0		3.40 ± 0.10
B1max.		4.35
D0		1.50 + 0.1, -0
F		3.5 ± 0.05
E1		1.75 ± 0.10
E2min.		6.25
T		0.6
T1max.		0.1
K0		1.04 ± 0.1
Leader min.		390
Trailer min.		160
Reel Dimensions		
A max.		178
N min.		60
W1		9 ± 0.5
W2		12.6 ± 0.5

EIA Tape Component Dimensions

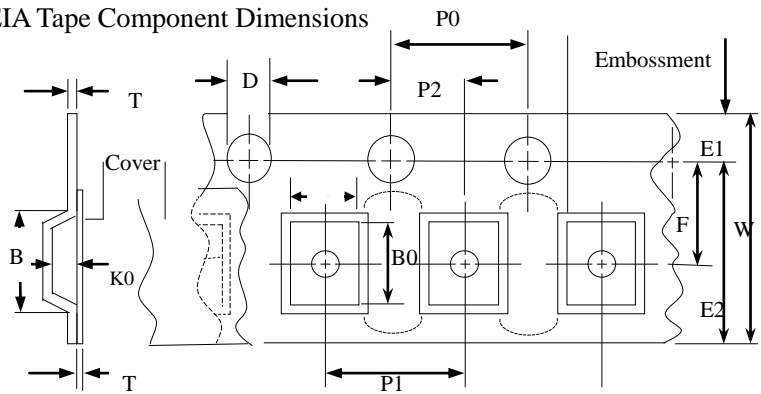

EIA Reel Dimensions

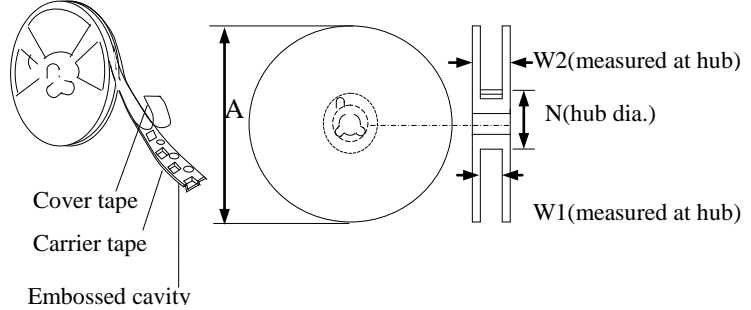

Storage And Handling

- Storage conditions: 30°C max, 30%~60% R.H.
- Devices may not meet specified performance if storage conditions are exceeded.

Part Number System

SMD 1206 R □□□ S F □□ V

